

## SMCJ5.0(C)A - SMCJ170(C)A

### Features

- Glass passivated junction.
- 1500 W Peak Pulse Power capability on 10/1000  $\mu$ s waveform.
- Excellent clamping capability.
- Low incremental surge resistance.
- Fast response time; typically less than 1.0 ps from 0 volts to BV for unidirectional and 5.0 ns for bidirectional.
- Typical  $I_R$  less than 1.0  $\mu$ A above 10V.
- UL certified, UL #E210467.

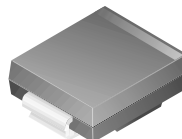

**SMC/DO-214AB**  
COLOR BAND DENOTES CATHODE ON UNIDIRECTIONAL DEVICES ONLY. NO COLOR BAND ON BIDIRECTIONAL DEVICES.

### DEVICES FOR BIPOLAR APPLICATIONS

- Bidirectional types use CA suffix.
- Electrical Characteristics apply in both directions.

## 1500 Watt Transient Voltage Suppressors

### Absolute Maximum Ratings\* $T_A = 25^\circ\text{C}$ unless otherwise noted

Symbol	Parameter	Value	Units
$P_{PPM}$	Peak Pulse Power Dissipation on 10/1000 $\mu$ s waveform	minimum 1500	W
$I_{PPM}$	Peak Pulse Current on 10/1000 $\mu$ s waveform	see table	A
$I_{FSM}$	Non-repetitive Peak Forward Surge Current superimposed on rated load (JEDEC method) (Note 1)	200	A
$T_{stg}$	Storage Temperature Range	-55 to +150	$^\circ\text{C}$
$T_J$	Operating Junction Temperature	-55 to +150	$^\circ\text{C}$

\*These ratings are limiting values above which the serviceability of any semiconductor device may be impaired.

**Note 1:** Measured on 8.3 ms single half-sine wave or equivalent square wave; Duty cycle = 4 pulses per minute maximum.

# Transient Voltage Suppressors

(continued)

## Electrical Characteristics

T<sub>A</sub> = 25°C unless otherwise noted

Uni-directional Bi-directional (C) Device	Part Marking*	Reverse Stand-off Voltage V <sub>RWM</sub> (V)	Breakdown Voltage V <sub>BR</sub> (V)		Test Current I <sub>T</sub> (mA)	Max Clamping Voltage @IPPM V <sub>C</sub> (V)	Max Peak Pulse Surge Current I <sub>PPM</sub> (A)	Max Reverse Leakage V <sub>RWM</sub> I <sub>R</sub> (uA)**
			min	max				
SMCJ5.0(C)A	GDE	5.0	6.40	7.0	10	9.2	163.0	1000
SMCJ6.0(C)A	GDG	6.0	6.67	7.37	10	10.3	145.6	1000
SMCJ6.5(C)A	GDK(BDK)	6.5	7.22	7.98	10	11.2	133.9	500
SMCJ7.0(C)A	GDM	7.0	7.78	8.60	10	12.0	125.0	200
SMCJ7.5(C)A	GDP(BDP)	7.5	8.33	9.21	1	12.9	116.3	100
SMCJ8.0(C)A	GDR(BDR)	8.0	8.89	9.83	1	13.6	110.3	50
SMCJ8.5(C)A	GDT(BDT)	8.5	9.44	10.4	1	14.4	104.2	20
SMCJ9.0(C)A	GDV(BDV)	9.0	10.0	11.1	1	15.4	97.4	10
SMCJ10(C)A	GDX(BDX)	10	11.1	12.3	1	17.0	88.2	5
SMCJ11(C)A	GDZ	11	12.2	13.5	1	18.2	82.4	5
SMCJ12(C)A	GEE(BEE)	12	13.3	14.7	1	19.9	75.3	5
SMCJ13(C)A	GEG	13	14.4	15.9	1	21.5	69.8	5
SMCJ14(C)A	GEK(BEK)	14	15.6	17.2	1	23.2	64.7	5
SMCJ15(C)A	GEM(BEM)	15	16.7	18.5	1	24.4	61.5	5
SMCJ16(C)A	GEP	16	17.8	19.7	1	26.0	57.7	5
SMCJ17(C)A	GER	17	18.9	20.9	1	27.6	54.3	5
SMCJ18(C)A	GET(BET)	18	20.0	22.1	1	29.2	51.4	5
SMCJ20(C)A	GEV(BEV)	20	22.2	24.5	1	32.4	46.3	5
SMCJ22(C)A	GEX(BEX)	22	24.4	26.9	1	35.5	42.3	5
SMCJ24(C)A	GEZ(BEZ)	24	26.7	29.5	1	38.9	38.6	5
SMCJ26(C)A	GFE(BFE)	26	28.9	31.9	1	42.1	35.6	5
SMCJ28(C)A	GFG(BFG)	28	31.1	34.4	1	45.4	33.0	5
SMCJ30(C)A	GFK(BFK)	30	33.3	36.8	1	48.4	31.0	5
SMCJ33(C)A	GFM(BFM)	33	36.7	40.6	1	53.3	28.1	5
SMCJ36(C)A	GFP(BFP)	36	40.0	44.2	1	58.1	25.8	5
SMCJ40(C)A	GFR(BFR)	40	44.4	49.1	1	64.5	23.3	5
SMCJ43(C)A	GFT(BFT)	43	47.8	52.8	1	69.4	21.6	5
SMCJ45(C)A	GFV	45	50.0	55.3	1	72.7	20.6	5
SMCJ48(C)A	GFX	48	53.3	58.9	1	77.4	19.4	5
SMCJ51(C)A	GFZ	51	56.7	62.7	1	82.4	18.2	5
SMCJ54(C)A	GGE	54	60.0	66.3	1	87.1	17.2	5
SMCJ58(C)A	GGG	58	64.4	71.2	1	93.6	16.0	5
SMCJ60(C)A	G GK	60	66.7	73.7	1	96.8	15.5	5
SMCJ64(C)A	GGM	64	71.1	78.6	1	103.0	14.6	5
SMCJ70(C)A	G GP	70	77.8	86.0	1	113.0	13.3	5
SMCJ75(C)A	GGR	75	83.3	92.1	1	121.0	12.4	5
SMCJ78(C)A	GGT	78	86.7	95.8	1	126.0	11.9	5
SMCJ85(C)A	GGV	85	94.4	104.0	1	137.0	10.9	5
SMCJ90(C)A	GGX	90	100.0	111.1	1	146.0	10.3	5
SMCJ100(C)A	GGZ	100	111.0	123.0	1	162.0	9.3	5
SMCJ110(C)A	GHE	110	122.0	135.0	1	177.0	8.5	5
SMCJ120(C)A	GHG	120	133.0	147.0	1	193.0	7.8	5
SMCJ130(C)A	GHK	130	144.0	159.0	1	209.0	7.2	5
SMCJ150(C)A	GHM	150	167.0	185.0	1	243.0	6.2	5
SMCJ160(C)A	GHP	160	178.0	197.0	1	259.0	5.8	5
SMCJ170(C)A	GHR	170	189.0	209.0	1	275.0	5.5	5

\* Color band denotes cathode on unidirectional devices only. No color band on bidirectional devices.

\*\* For bidirectional parts with V<sub>RWM</sub> < 10V, the I<sub>R</sub> max limit is doubled.

SMCJ5.0(C)A - SMCJ170(C)A

Typical Characteristics

Peak Pulse Power Rating Curve

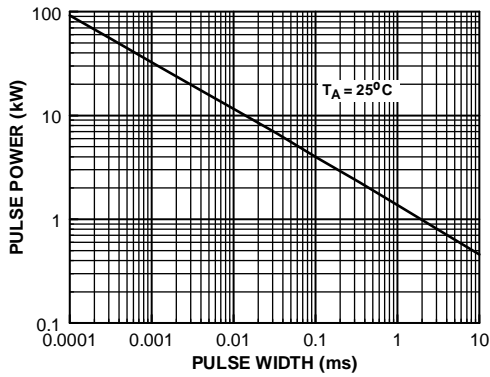

Pulse Derating Curve

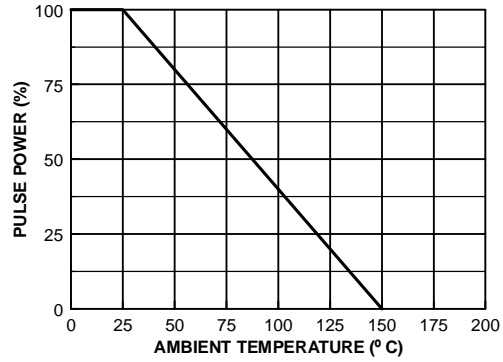

Pulse Waveform

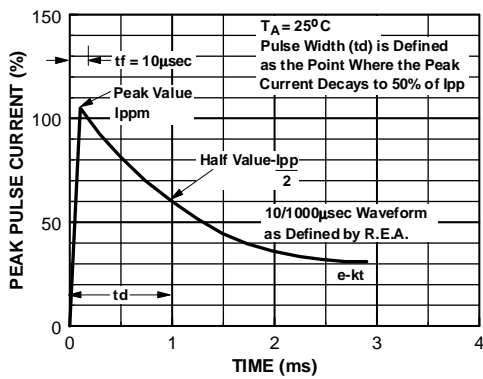

Junction Capacitance

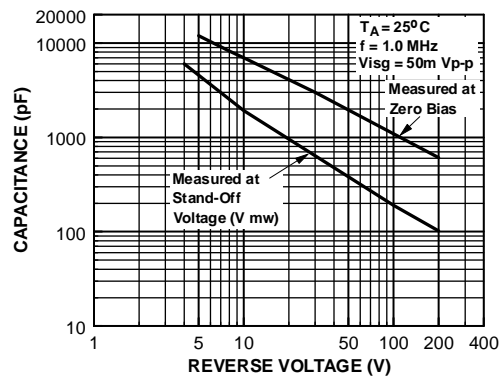

Non-Repetitive Surge Current

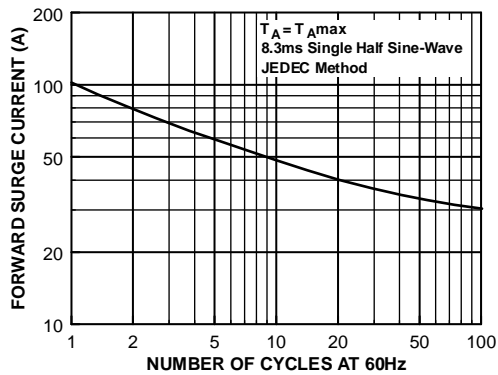

# DO-214AB(SMC) Tape and Reel Data



## DO-214AB(SMC) Packaging Configuration: Figure 1.0

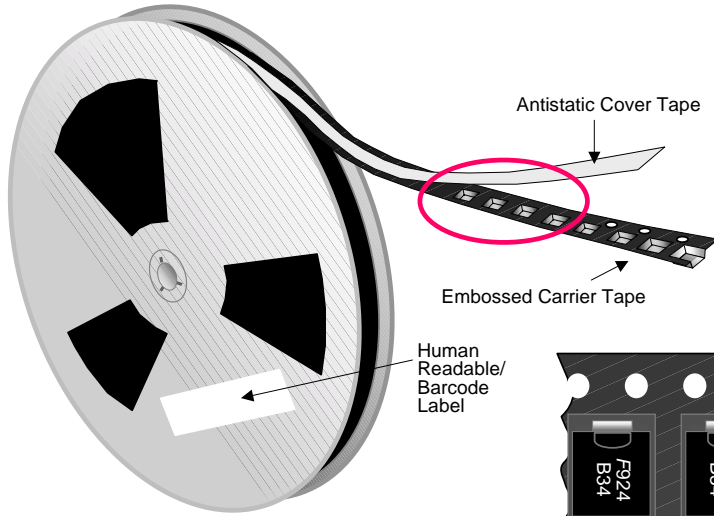

**Packaging Description:**  
 DO-214AB(SMC) parts are shipped in tape. The carrier tape is made from a dissipative (carbon filled) polycarbonate resin. Alternate carrier tape is made of anti-static plastic. The cover tape is a multilayer film (Heat Activated Adhesive in nature) primarily composed of polyester film, adhesive layer, sealant, and anti-static sprayed agent. These reeled parts in standard option are shipped with 7,500 units per 13" or 330cm diameter reel. The reel comes in plastic or carton which is made of polystyrene plastic (anti-static coated) and thick white paper respectively. Further information is described in the Packaging Information table.  
 These full reels are individually labeled and placed inside a bleach box (illustrated in figure 1.0) made of recyclable carton paper with a Fairchild logo printing. One box contains two reels maximum. Certain number of these boxes are placed inside shipping box which comes in different sizes depending on the number of parts shipped.

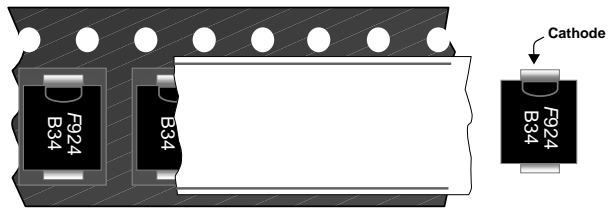

DO-214AB(SMC) unit orientation

DO-214AB(SMC) Packaging Information		
Packaging Option	Under package code P5	Under package code MA
Packaging type	TNR	TNR
Qty per Reel/Tube/Bag	3,000	3,000
Reel Size (inch diameter)	13	13
Box Dimension (mm)	336x336x38	336x336x38
Max qty per Box	6,000	6,000
Weight per unit (gm)	0.210	0.210
Weight per Reel (kg)	1.130	1.130
Note/Comments	Human readable label	Barcode label

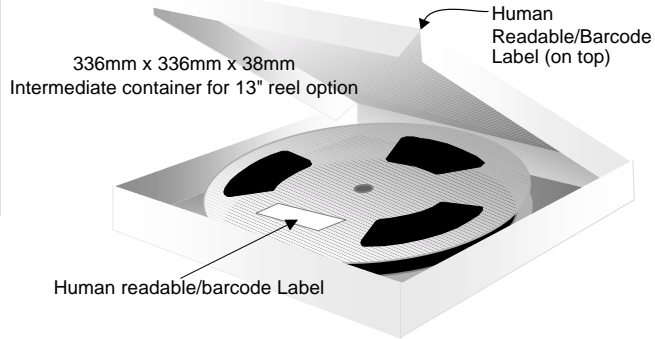

### Human Readable Label sample



### F63TNR Label sample

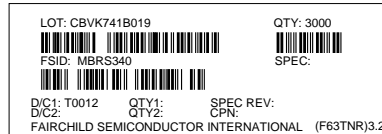

## DO-214AB(SMC) Tape Leader and Trailer Configuration: Figure 2.0

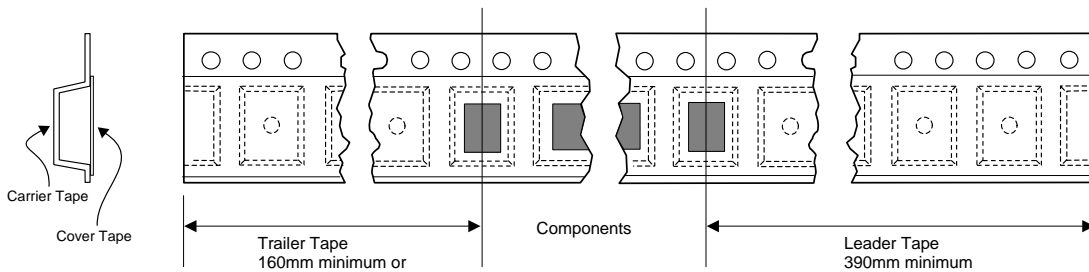

# DO-214AB(SMC) Tape and Reel Data, continued

## DO-214AB(SMC) Embossed Carrier Tape Configuration: Figure 3.0

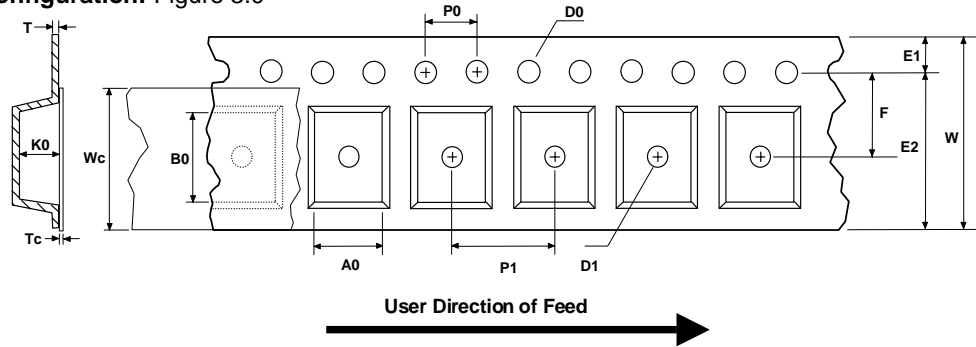

Dimensions are in millimeter

Pkg type	A0	B0	W	D0	D1	E1	E2	F	P1	P0	K0	T	Wc	Tc
DO-214AB(SMC) (12mm)	6.00 +/-0.15	8.25 +/-0.20	16.0 +/-0.3	1.55 +/-0.05	1.125 +/-0.125	1.75 +/-0.10	10.25 min	7.5 +/-0.05	8.0 +/-0.1	4.0 +/-0.1	2.4 +/-0.30	0.40 +/-0.10	13.0 +/-0.3	0.06 +/-0.02

Notes: A0, B0, and K0 dimensions are determined with respect to the EIA/Jedec RS-481 rotational and lateral movement requirements (see sketches A, B, and C).

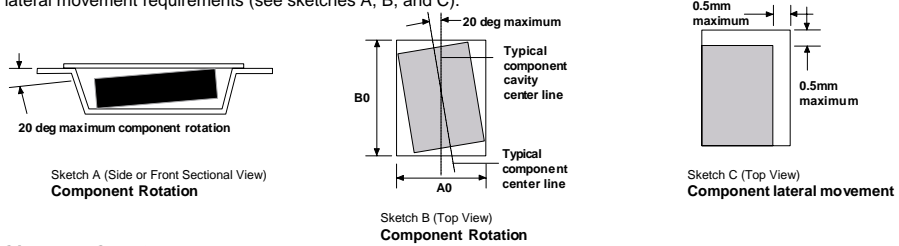

## DO-214AB(SMC) Reel Configuration: Figure 4.0

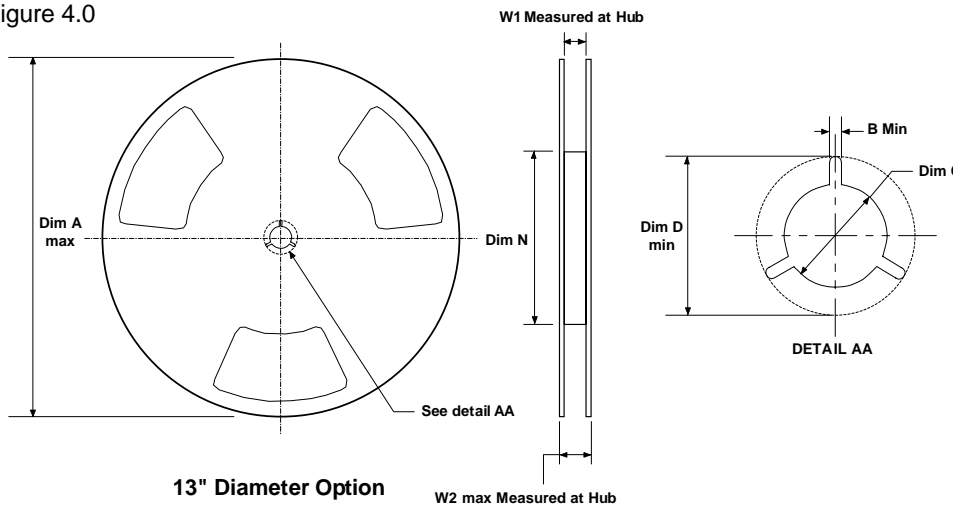

Dimensions are in inches and millimeters

Tape Size	Reel Option	Dim A	Dim B	Dim C	Dim D	Dim N	Dim W1	Dim W2
12mm	13" Dia	13.0 330	0.059 1.5	512 +0.020/-0.008 13 +0.5/-0.2	0.795 20.2	1.97 50 min	0.646 +0.078/-0.000 16.4 +2/-0	0.724 18.4

# DO-214AB(SMC) Package Dimensions



## DO-214AB(SMC) (FS PKG Code P7)

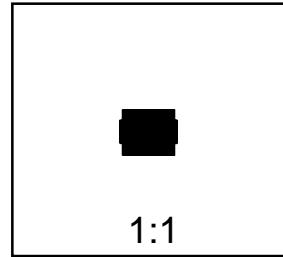
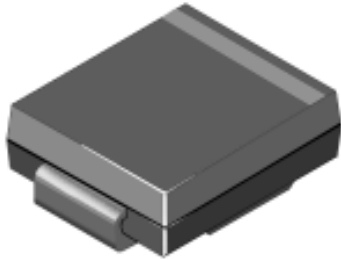

Scale 1:1 on letter size paper

Dimensions shown below are in:  
inches [millimeters]

Part Weight per unit (gram): 0.21

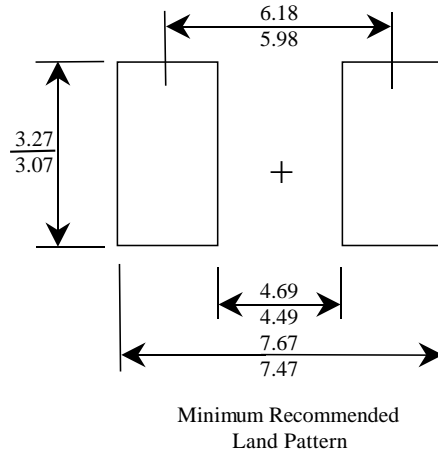
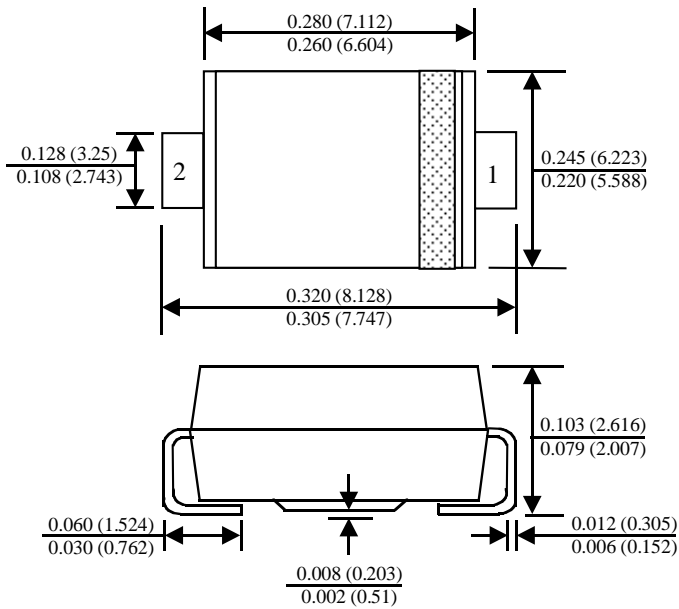

## TRADEMARKS

The following are registered and unregistered trademarks Fairchild Semiconductor owns or is authorized to use and is not intended to be an exhaustive list of all such trademarks.

ACE <sub>x</sub> <sup>TM</sup>	FAST <sup>®</sup>	PACMAN <sup>TM</sup>	SuperSOT <sup>TM</sup> -3
Bottomless <sup>TM</sup>	FAST <sub>r</sub> <sup>TM</sup>	POP <sup>TM</sup>	SuperSOT <sup>TM</sup> -6
CoolFET <sup>TM</sup>	GlobalOptoisolator <sup>TM</sup>	PowerTrench <sup>®</sup>	SuperSOT <sup>TM</sup> -8
CROSSVOLT <sup>TM</sup>	GTO <sup>TM</sup>	QFET <sup>TM</sup>	SyncFET <sup>TM</sup>
DenseTrench <sup>TM</sup>	HiSeC <sup>TM</sup>	QS <sup>TM</sup>	TinyLogic <sup>TM</sup>
DOMET <sup>TM</sup>	ISOPLANAR <sup>TM</sup>	QT Optoelectronics <sup>TM</sup>	UHC <sup>TM</sup>
EcoSPARK <sup>TM</sup>	LittleFET <sup>TM</sup>	Quiet Series <sup>TM</sup>	UltraFET <sup>®</sup>
E <sup>2</sup> CMOS <sup>TM</sup>	MicroFET <sup>TM</sup>	SILENT SWITCHER <sup>®</sup>	VCX <sup>TM</sup>
EnSigna <sup>TM</sup>	MICROWIRE <sup>TM</sup>	SMART START <sup>TM</sup>	
FACT <sup>TM</sup>	OPTOLOGIC <sup>TM</sup>	Star* Power <sup>TM</sup>	
FACT Quiet Series <sup>TM</sup>	OPTOPLANAR <sup>TM</sup>	Stealth <sup>TM</sup>	

## DISCLAIMER

FAIRCHILD SEMICONDUCTOR RESERVES THE RIGHT TO MAKE CHANGES WITHOUT FURTHER NOTICE TO ANY PRODUCTS HEREIN TO IMPROVE RELIABILITY, FUNCTION OR DESIGN. FAIRCHILD DOES NOT ASSUME ANY LIABILITY ARISING OUT OF THE APPLICATION OR USE OF ANY PRODUCT OR CIRCUIT DESCRIBED HEREIN; NEITHER DOES IT CONVEY ANY LICENSE UNDER ITS PATENT RIGHTS, NOR THE RIGHTS OF OTHERS.

## LIFE SUPPORT POLICY

FAIRCHILD'S PRODUCTS ARE NOT AUTHORIZED FOR USE AS CRITICAL COMPONENTS IN LIFE SUPPORT DEVICES OR SYSTEMS WITHOUT THE EXPRESS WRITTEN APPROVAL OF FAIRCHILD SEMICONDUCTOR CORPORATION. As used herein:

1. Life support devices or systems are devices or systems which, (a) are intended for surgical implant into the body, or (b) support or sustain life, or (c) whose failure to perform when properly used in accordance with instructions for use provided in the labeling, can be reasonably expected to result in significant injury to the user.
2. A critical component is any component of a life support device or system whose failure to perform can be reasonably expected to cause the failure of the life support device or system, or to affect its safety or effectiveness.

## PRODUCT STATUS DEFINITIONS

### Definition of Terms

Datasheet Identification	Product Status	Definition
Advance Information	Formative or In Design	This datasheet contains the design specifications for product development. Specifications may change in any manner without notice.
Preliminary	First Production	This datasheet contains preliminary data, and supplementary data will be published at a later date. Fairchild Semiconductor reserves the right to make changes at any time without notice in order to improve design.
No Identification Needed	Full Production	This datasheet contains final specifications. Fairchild Semiconductor reserves the right to make changes at any time without notice in order to improve design.
Obsolete	Not In Production	This datasheet contains specifications on a product that has been discontinued by Fairchild semiconductor. The datasheet is printed for reference information only.